

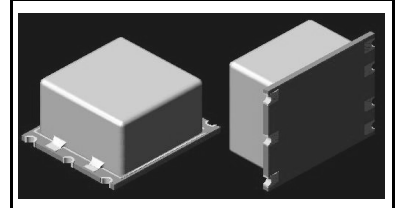

# Preliminary



## XOCSM103

## 10.000000 MHz OCXO



- **Oven Controlled, Voltage Tuned Crystal Oscillator**
- **Very High Frequency Stability and Accuracy with Fast Warm-up**
- **Low Phase Noise and Jitter**
- **Low Power Consumption, Small Size**
- **Oscillator Output Enable and Oven Alarm**
- **Typical Applications Include:**
  - Cellular Base Stations
  - Communication Test Equipment
  - Precision Frequency Synthesizers
- **Complies with Directive 2002/95/EC (RoHS)** 

### Electrical Characteristics

Characteristic	Sym	Notes	Minimum	Typical	Maximum	Units
Nominal Operating Frequency	fo			10.000000		MHz
Fixed-tuned Frequency Tolerance, 25 °C, 2.5 V Tuning Input, 10 Minutes after Warm-up, 72 Hours after Reflow Soldering					±100	ppb
Warm-up Time to ±100 ppb at 25 °C, 2.5 V Tuning Input					10	minutes
Fixed-tuned Stability, 2.5 V Tuning Input, -20 to +70 °C		1			±5	ppb
Fixed-tuned Stability, 2.5 V Tuning Input, ±5% Power Supply Variation		2			±0.5	
Fixed-tuned Stability, 2.5 V Tuning Input, 50 Ω ±5%					±0.5	
Tuning Input Voltage Range			0		5.00	V
Tuning Input Sensitivity (tuning range for 15 years aging drift)			0.3		0.6	ppm/V
Tuning Input Non-linearity (monotonic positive slope)					10	%
Tuning Input Impedance			100K			Ω
Tuning Reference Voltage			4.93		5.07	V
Tuning Reference Voltage Temperature and Aging Drift					<±0.2	%
Tuning Reference Voltage Internal Resistance					100	Ω
Nominal Output Waveform			sinewave			
Output Power into 50 Ω Load	P <sub>O</sub>		5		10	dBm
Output Harmonic Spurious Level, except 9 to 11 MHz					-20	dBc
Output Non-harmonic Spurious Level, 9 to 11 MHz					-90	
Output Load				50 ±5%		Ω
Oscillator Enable ON Voltage Range			2.4		12.6	V
Oscillator Enable Input Impedance			100K			Ω
Oven Failure Alarm Ready Output Voltage			2.4		3.6	V
Oven Failure Alarm Output Voltage			0		0.4	
Oven Failure Alarm Load Impedance			30K	100K		Ω
Oscillator Tolerance when Alarm Ready Output Set					±1000	ppb
Characterized Operating Temperature Range	T <sub>O</sub>		-20		70	°C
Maximum Operating Temperature Range	T <sub>M</sub>		-30		80	
Storage Temperature Range	T <sub>S</sub>		-40		80	
Power Supply Voltage Range			10.5	12.0	12.6	V
Power Supply Current at -20 °C, Steady-state Conditions					400	mA
Power Supply Current at 0 °C, Steady-state Conditions					380	
Power Supply Current at 25 °C, Steady-state Conditions					340	

## Electrical Characteristics

Characteristic	Sym	Notes	Minimum	Typical	Maximum	Units
Fixed-tuned Medium/Long-term Stability, 2.5 V Tuning Input:						
1 Day					±0.5	ppb
1 Month					±5	
1 Year					±30	
15 Years					±500	
Fixed-tuned Frequency Retrace, 24 hours ON, 2 hours OFF, 1 hour ON, frequency difference after first 24 hours ON and second 1 hour ON					±5	ppb
SSB Phase Noise:						
@ 0.1 Hz offset				-70		dBc/Hz
@ 1 Hz offset					-100	
@ 10 Hz offset					-130	
@ 100 Hz offset					-145	
@ 1 kHz offset					-150	
@ 10 and 100 kHz offset					-150	
Short-term Stability, after 1 Hour of Operation:						
1 second					5.0E-12	
10 seconds					1.0E-11	
100 seconds					1.0E-10	
Heat/Humidity Test, DIN IEC 68-2-3 ... 68-2-30					+25/+40	°C
Relative Humidity, Non-condensing					90	%
Non-operating Shock, DIN IEC 68-2-27					40	g
Operating Sinewave Vibration, DIN IEC 68-2-6			5		150	Hz
Operating Sinewave Vibration, DIN IEC 68-2-36			10		300	Hz
Weight					40	gm
Case Height	H Max				12.5	mm
Lid Symbolization			per specification HVC181			
Production Standard			IPC-A-610 Class 2			

**CAUTION: Electrostatic Sensitive Device. Observe precautions for handling.**



### Notes:

1. Frequency stability versus orientation less than 1 ppb.
2. Frequency stability versus supply voltage 0.5 ppb maximum due to dynamic or static load changes ±100 mV with rise/fall time of 50 to 100 µs.
3. Operating air pressure 54 kpa, non-operating 26 kpa.
4. MTBF 100,000 hours at 45 °C.
5. The design, manufacturing process, and specifications of this device are subject to change without notice.

# 7-Pin SMT Case, 22 x 24.5 x 12.5 mm Nominal Dimensions

## Case Outline Drawing

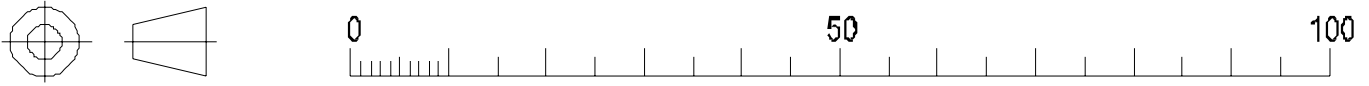

### BOTTOM VIEW

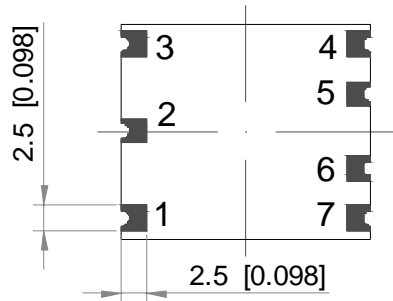

### SUGGESTED PAD

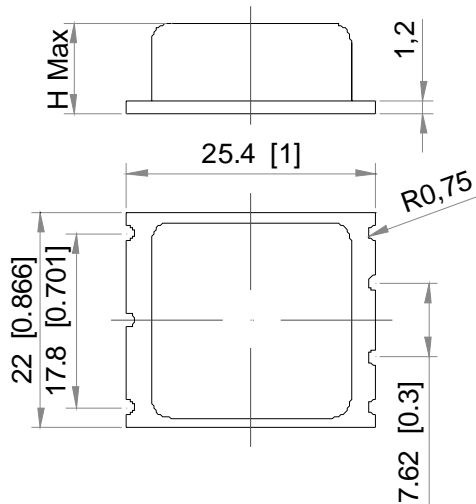
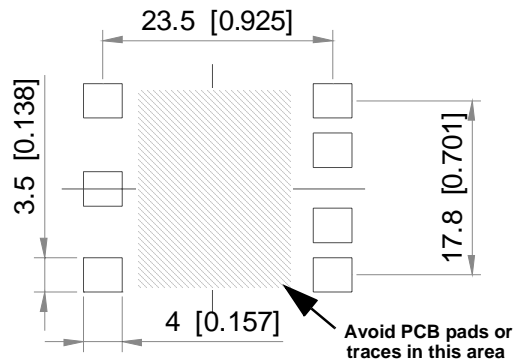

### Pin Functions

Pin	Connection
1	Oscillator Output
2	Oven Alarm Output
3	Case/Circuit Ground
4	Tuning Voltage Reference Output
5	Tuning Voltage Input
6	Oscillator Enable Input
7	Power Supply Voltage Input

### Application Circuit

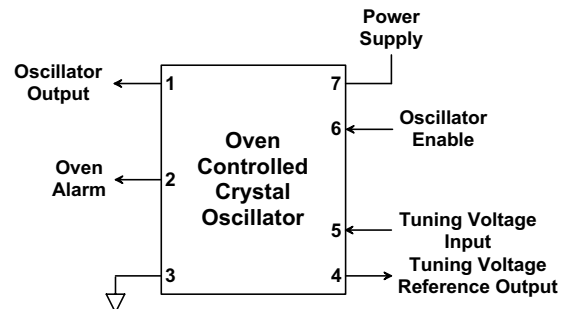

## Typical Reflow Profile

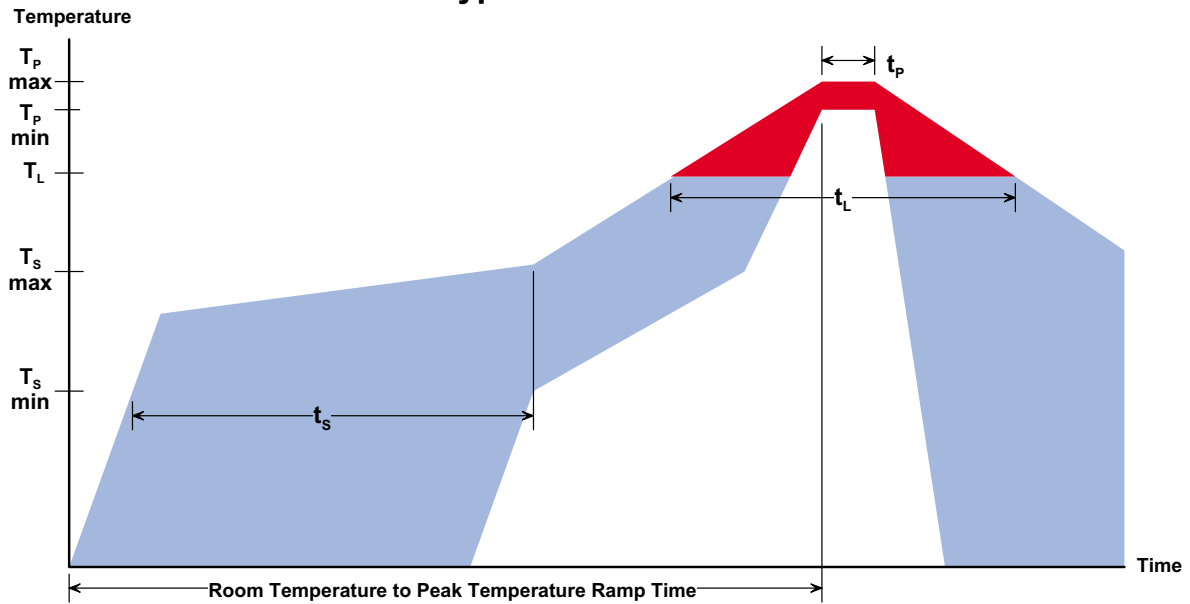

Profile Specification	Pb-Free Assembly	Sn-Pb Assembly
$T_S$ min Preheat Temperature	140 °C	120 °C
$T_S$ max Preheat Temperature	210 °C	180 °C
$T_S$ min to $T_S$ max ramp time, $t_s$	30 to 120 seconds	30 to 120 seconds
$T_L$ Transition Temperature	220 °C	185 °C
Time above $T_L$ , $t_L$	30 to 120 seconds	30 to 120 seconds
$T_S$ max to $T_L$ Maximum Ramp Rate	3 °C/second	3 °C/second
$T_P$ min Peak Temperature	230	200
$T_P$ max Peak Temperature	245	235
Maximum Time at Peak Temperature, $t_p$	15 seconds	15 seconds
$T_L$ to $T_P$ Maximum Ramp Rate	3 °C/seconds	3 °C/seconds
Maximum Room to Peak Temperature Time	480 seconds	360 seconds